



Jackfish J1/J2 Spectroelectrochemical Cells

The information in this publication is provided for reference only. All information contained in this publication is believed to be correct and complete. PIKE Technologies, Inc. shall not be liable for errors contained herein nor for incidental or consequential damages in connection with the furnishing, performance, or use of this material. All product specifications, as well as the information contained in this publication, are subject to change without notice. This publication may contain or reference information and products protected by copyrights or patents and does not convey any license under the patent rights of PIKE Technologies, Inc. nor the rights of others. PIKE Technologies, Inc. does not assume any liability arising out of any infringements of patents or other rights of third parties.

This document contains confidential or proprietary information of PIKE Technologies, Inc. Neither this document nor the information herein is to be reproduced, distributed, used or disclosed, either in whole or in part, except as specifically authorized by PIKE Technologies, Inc.

PIKE Technologies, Inc. makes no warranty of any kind with regard to this material including, but not limited to, the implied warranties of merchantability and fitness for a particular purpose.

Copyright 1991-2025 by PIKE Technologies, Inc., Madison, WI 53719. Printed in the United States of America. All world rights reserved. No part of this publication may be stored in a retrieval system, transmitted, or reproduced in any way, including but not limited to, photocopy, photograph, magnetic or other record, without the prior written permission of PIKE Technologies, Inc.

Address comments to:

PIKE Technologies, Inc.
6125 Cottonwood Drive
Madison, WI 53719

Phone	(608) 274-2721
Fax	(608) 274-0103
Email	info@piketech.com
Web Site	www.piketech.com

April 6, 2025

Contents

1	Introduction	1
2	Unpacking Your Accessory	2
3	Cell Assembly	2
4	JF Face-Angled Crystal Cell Base	3
4.1	Packing List	3
4.1.1	Option 1: JxFP Cell Base Kit	4
4.1.2	Option 2: JxFT Cell Base Kit	4
4.2	Assembly	5
4.2.1	Assemble Contact Pins	5
4.2.2	Fasten Glass Body to Cell Base	5
4.2.3	Load the Crystal	5
4.2.4	Attach the Cell	6
4.2.5	Making Contact with the Crystal	6
5	JW ATR Wafer Cell Base	8
5.1	Packing List	8
5.1.1	Option 1: JxWP Cell Base Kit	9
5.1.2	Option 2: JxWT Cell Base Kit	9
5.2	Assembly	10
5.2.1	Assemble Contact Pins	10
5.2.2	Fasten Glass Body to Cell Base	10
5.2.3	Loading Microgrooved Wafers	11
5.2.4	Fasten the Cell to the Top Plate	12
5.2.5	Making Contact with the Wafer	13
6	J1 Glassware	15
6.1	Packing List	15
6.2	Assembling the Cell	16
6.2.1	J1 Reference Electrode Assembly	16
7	J2 Glassware	17
7.1	Packing List	17
7.2	Assembling the Cell	18
8	Gas Purge Top Cap Option	19
8.1	Packing List	19
8.2	Assembly	20
9	Installing the Jackfish Cell Assembly onto the VeeMAX III	20
10	Selecting the Angle of Incidence	20
11	Ag/AgCl Reference Electrode Maintenance	21
12	Cleaning	21
13	Comments on Material Properties and Chemical Compatibility	22
14	Support	22
15	Also Available From Jackfish SEC	23

1 Introduction

The Jackfish SEC Spectroelectrochemical Cell enables fundamental studies of the electrified metal-solution interface and applications in molecular self-assembly, interfacial sensing, and next-generation energy solutions. It is designed for surface-sensitive FTIR spectroelectrochemistry using the attenuated total reflectance surface-enhanced infrared spectroscopy (ATR-SEIRAS) technique. High quality IR spectra can be obtained from sub-monolayer amounts of adsorbed molecules. By controlling the electrical potential applied to the Au thin film electrode on the ATR crystal surface, the user can perform vibrational characterization of potential-dependent changes at the interface.

By design, the cell is fully compatible with the PIKE VeeMAX III variable angle ATR sampling accessory. Two different crystals can be accommodated: the JF fits the PIKE face-angled crystal (FAC) and the JW is designed for use with microgrooved ATR wafers. In a previous study investigating the adsorption of a pyridine derivative, the spectral response was two times stronger when using Si 60 degrees FAC compared to a Si hemisphere with an angle of incidence of 65 degrees¹. Additionally, the FAC exhibited higher energy throughput and lower spectral noise. The short pathlength through the ATR wafers allows improved signal-to-noise in the fingerprint region of the IR spectrum and a lower frequency cutoff compared to the FAC.



J1F Cell assembled on the VeeMAX III Jackfish top plate.

¹Sigrist, J. A. et al. Optimization of a Commercial Variable Angle Accessory for Entry Level Users of Electrochemical Attenuated Total Reflection Surface-Enhanced Infrared Absorption Spectroscopy (ATR-SEIRAS). *Applied Spectroscopy* **2019**, 73 (12), 1394–1402, DOI: [10.1177/0003702819858353](https://doi.org/10.1177/0003702819858353).

2 Unpacking Your Accessory

In order for you to quickly verify receipt of your accessory, we have included a packing list. Please inspect the package carefully. Contact PIKE Technologies immediately if any discrepancies are found.





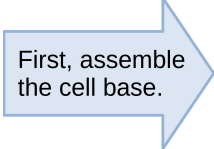
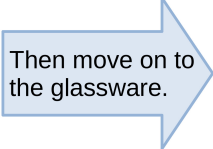







3 Cell Assembly

To assemble your cell, first follow the assembly instructions for your cell base type (JF or JW), and then complete the assembly of the glassware (J1 or J2). The following table provides the relevant page numbers for each cell model.

Cell Model		Cell Base		Glassware
J1F		JF: Face-Angled Crystal (p 2)		J1: (p 14)
J1W		JW: ATR Wafer (p 6)		J2: (p 16)
J2F		JF: Face-Angled Crystal (p 2)		J1: (p 14)
J2W		JW: ATR Wafer (p 6)		J2: (p 16)

4 JF Face-Angled Crystal Cell Base

4.1 Packing List

<p>60 degree FAC holder, PEEK P.N. 162-4745 Qty. 1</p> 	<p>-116 FKM o-ring, 60A durometer, white P.N. 162-4726 Qty. 2</p> 	<p>-012 FKM o-ring, 60A durometer, white P.N. 162-4724 Qty. 2</p> 
<p>-116 FFKM o-ring, 75A durometer, black P.N. 162-4770 Qty. 1</p> 	<p>-012 FFKM o-ring, 75A durometer, black P.N. 162-4771 Qty. 1</p> 	<p>#8-32 screw, stainless steel, 1/2" long Qty. 12</p> 
<p>#2-56 contact screw, stainless steel Qty. 4</p> 	<p>#2-56 pin-retaining screw, nylon black Qty. 4</p> 	<p>Contact screw spacer, stainless steel Qty. 2</p> 
<p>Gold pogo pin Qty. 4</p> 	<p>5/64" ball-end screwdriver Qty. 1</p> 	<p>9/64" hex L-key Qty. 1</p> 

4.1.1 Option 1: JxFP Cell Base Kit



4.1.2 Option 2: JxFT Cell Base Kit

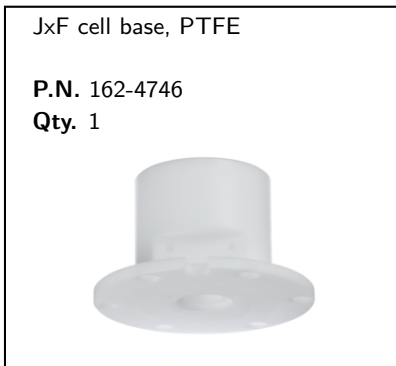

4.2 Assembly

4.2.1 Assemble Contact Pins

Slide a contact screw spacer over two of the #2-56 stainless steel contact screws (Figure 2a). Use the 5/64" hex screwdriver to install the contact screws into the uppermost screw holes on the side of the cell base (Figure 2b). Tighten them until they bottom out onto the spacer. Place a gold contact pin in each hole on the bottom of the cell base. Verify that the pins protrude out from the bottom surface of the cell base by approximately 2 mm (Figure 2c). If a pin does not protrude appreciably from its hole, it is likely that the corresponding contact screw was insufficiently tightened. Remove the pin, tighten down the contact screw, and check again. It is recommended to measure the resistance between the pin and its corresponding screw to ensure electrical contact.

Depress each pin and install a nylon #2-56 screw into the remaining (lower) hole for that pin. Tighten until the nylon screw contacts the pin and retains it in the compressed state. Note: the head of the nylon screw will not seat against the side of the cell base (Figure 2d).

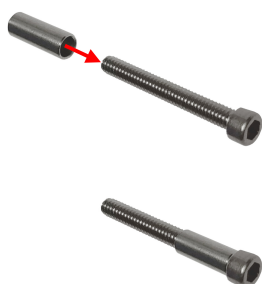

Figure 2(a): Installing the spacer on the stainless steel contact screw.

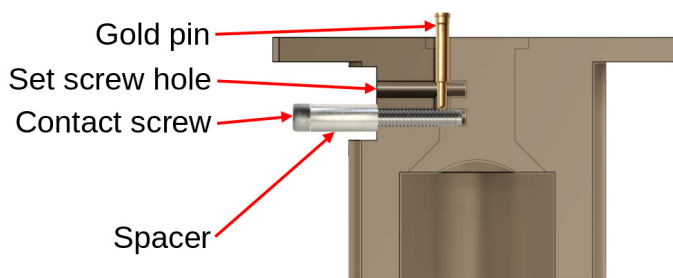

Figure 2(b): Cross-section of J1, flipped upside down so that the gold pin does not fall out.



Figure 2(c): The left pin protrudes correctly, however, the right pin has sunk to the bottom of the hole because the contact screw was tightened inadequately.

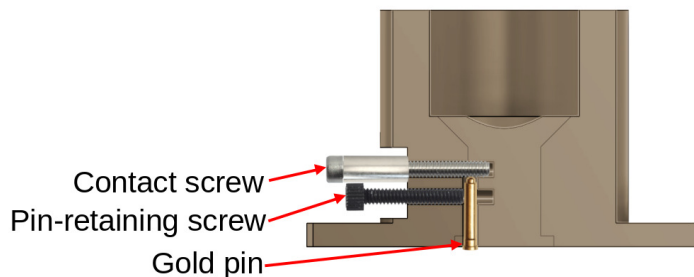

Figure 2(d): The nylon set screw retains the gold pin in the compressed state.

4.2.2 Fasten Glass Body to Cell Base

Insert the small (-012) lower O-ring into the pocket on the underside of the body (Figure 3a). Insert the large (-116) upper O-ring into the PEEK/PTFE cell base (Figure 3b). Thread the glass cell body into the base until it bottoms out and seals against the O-ring, being careful not to overtighten. You should not need to tighten more than 45 degrees ($1/8^{\text{th}}$ of a turn) past the point where you start to feel resistance.

4.2.3 Load the Crystal

Place the coated face-angled crystal in the holder and place in the VeeMAX III top plate, as shown in Figures 5a and 5b.

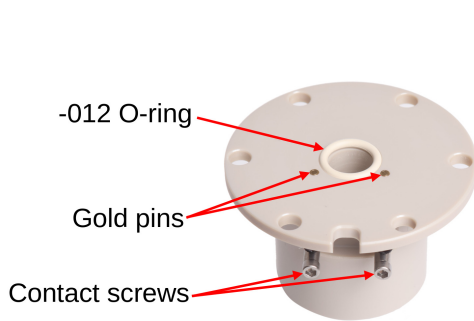

Figure 3(a): Install the -012 O-ring in the pocket on the underside of the cell base.



Figure 3(b): Install the -116 O-ring in the interior of the cell base.

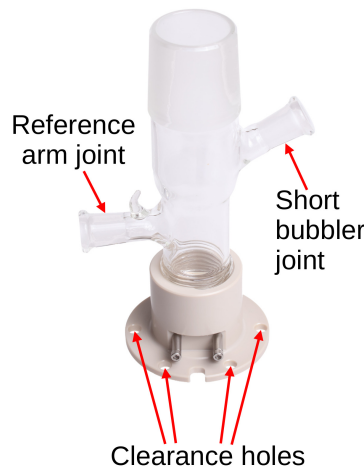



Figure 4: Glass body installed on the JF cell base.

 **IMPORTANT:** Remove the top plate from the VeeMAX III and secure to ensure it does not shift during assembly. The assembly and initial filling of the cell with electrolyte needs to be done off the VeeMAX III. This is to avoid damage to the VeeMAX III if a leak occurs.

 **IMPORTANT:** When placing the crystal holder with the FAC in the top plate, be sure the FAC is oriented correctly to allow for incident light through the FAC (Figure 5b).

4.2.4 Attach the Cell

Carefully fasten the cell assembly onto the VeeMAX III Jackfish top plate (specialized plate with round pocket to accommodate the Jackfish Cell) using the six screws (#8-32) provided. These screws are best fastened by hand (finger tight), although a 9/64" hex drive may be used if additional sealing force is required. Be sure to stabilize the cell and evenly tighten the screws in a star pattern to distribute pressure evenly while tightening (Figure 6). Tighten each screw with a 1/4 turn on each rotation to ensure an even distribution of pressure.

4.2.5 Making Contact with the Crystal

Loosen the two nylon pin-retaining screws (the lower screws only) counter-clockwise several full turns. This allows the spring-loaded pin to extend and make contact with the electrode surface. You may hear a click as the pin engages. Check for electrical contact by measuring the resistance across the three contact screws.

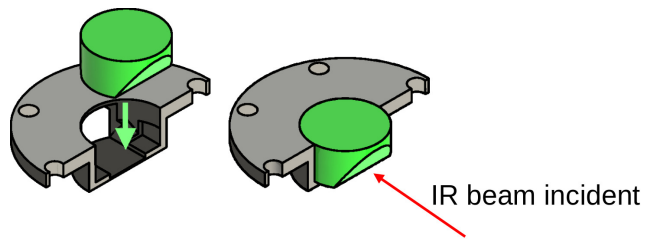

Figure 5(a): Orientation of FAC in cross-section of crystal holder.

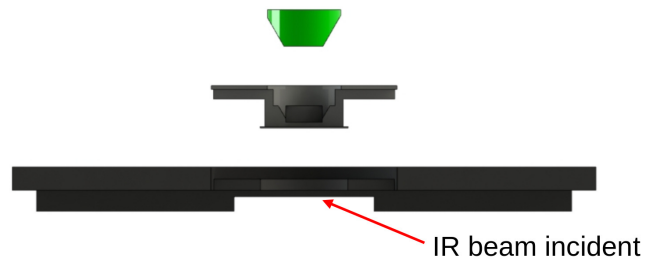

Figure 5(b): Orientation of FAC in crystal holder in top plate.

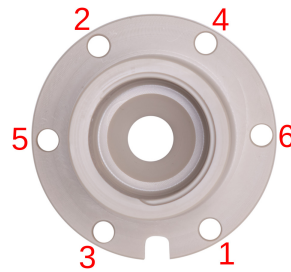

Figure 6: Order for tightening screws to apply an even sealing force.

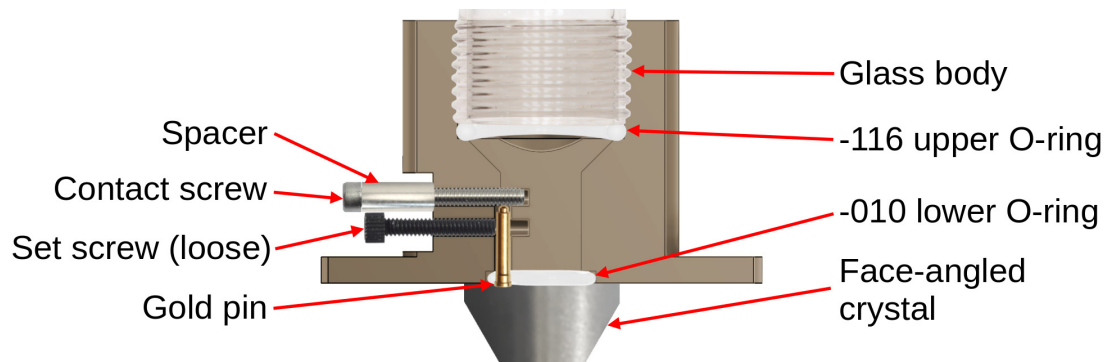













Figure 7: Cross-section of the cell assembled atop the crystal. The crystal holder is omitted for clarity.

5 JW ATR Wafer Cell Base

5.1 Packing List

<p>Wafer holder, PEEK P.N. 162-4751 Qty. 1</p> 	<p>-116 FKM o-ring, 60A durometer, white P.N. 162-4726 Qty. 2</p> 	<p>-010 FKM o-ring, 60A durometer, white P.N. 162-4725 Qty. 2</p> 
<p>-116 FFKM o-ring, 75A durometer, black P.N. 162-4770 Qty. 1</p> 	<p>-010 FFKM o-ring, 75A durometer, black P.N. 162-4772 Qty. 1</p> 	<p>#8-32 screw, stainless steel, 1/2" long Qty. 12</p> 
<p>#2-56 contact screw, stainless steel Qty. 4</p> 	<p>#2-56 pin-retaining screw, nylon black Qty. 4</p> 	<p>Gold pogo pin Qty. 4</p> 
<p>Contact screw spacer, stainless steel Qty. 2</p> 	<p>5/64" ball-end screwdriver Qty. 1</p> 	<p>9/64" hex L-key Qty. 1</p> 

5.1.1 Option 1: JxWP Cell Base Kit

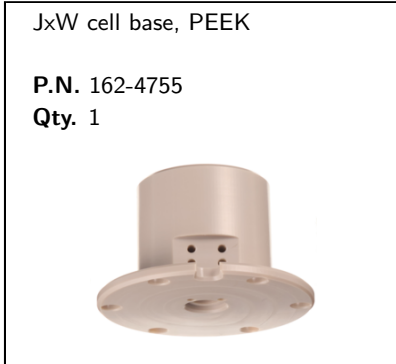

5.1.2 Option 2: JxWT Cell Base Kit

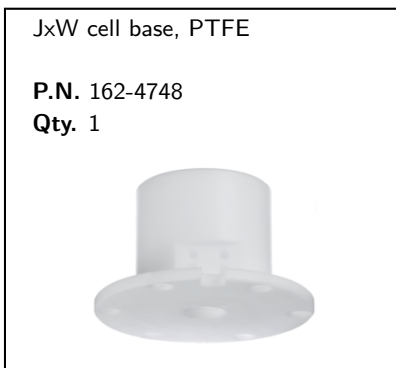

5.2 Assembly

5.2.1 Assemble Contact Pins

Slide a contact screw spacer over two of the #2-56 stainless steel contact screws (Figure 8a). Use the 5/64" hex screwdriver to install the contact screws into the uppermost screw holes on the side of the cell base (Figure 8b). Tighten them until they bottom out onto the spacer. Place a gold contact pin in each hole on the bottom of the cell base. Verify that the pins protrude out from the bottom surface of the cell base by approximately 2 mm (Figure 8c). If a pin does not protrude appreciably from its hole, it is likely that the corresponding contact screw was insufficiently tightened. Remove the pin, tighten down the contact screw, and check again. It is recommended to measure the resistance between the pin and its corresponding screw to ensure electrical contact.

Depress each pin and install a nylon #2-56 screw into the remaining (lower) hole for that pin. Tighten until the nylon screw contacts the pin and retains it in the compressed state. Note: the head of the nylon screw will not seat against the side of the cell base (Figure 8d).

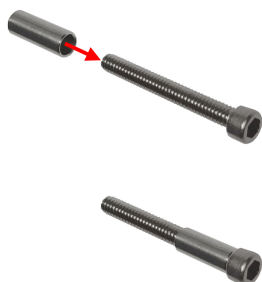

Figure 8(a): Installing the spacer on the stainless steel contact screw.

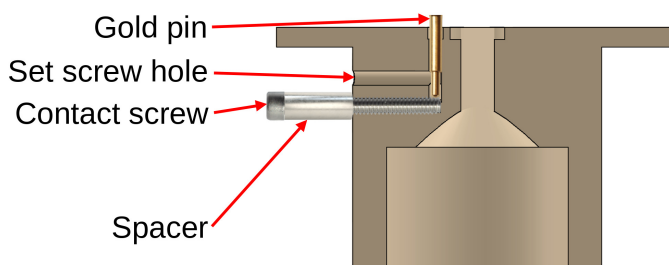

Figure 8(b): Cross-section of JW, flipped upside down so that the gold pin doesn't fall out.



Figure 8(c): The left pin protrudes correctly, however the right pin has sunk to the bottom of the hole because the contact screw was inadequately tightened.

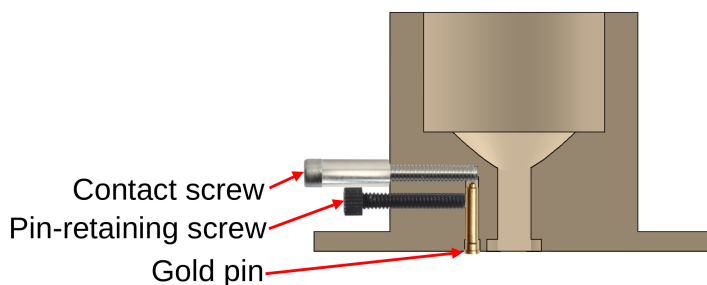

Figure 8(d): The nylon set screw retains the gold pin in the compressed state.

5.2.2 Fasten Glass Body to Cell Base

Insert the small (-012) lower O-ring into the pocket on the underside of the body (Figure 9a). Insert the large (-116) upper O-ring into the PEEK/PTFE cell base (Figure 9b). Thread the glass cell body into the base until it bottoms out and seals against the O-ring, being careful not to overtighten. You should not need to tighten more than 45 degrees ($1/8^{\text{th}}$ of a turn) past the point where you start to feel resistance.

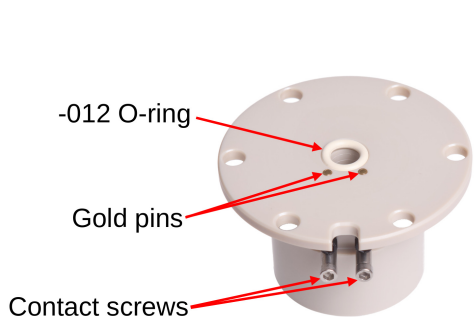

Figure 9(a): Install the -012 O-ring in the pocket on the underside of the cell base.



Figure 9(b): Install the -116 O-ring in the interior of the cell base.

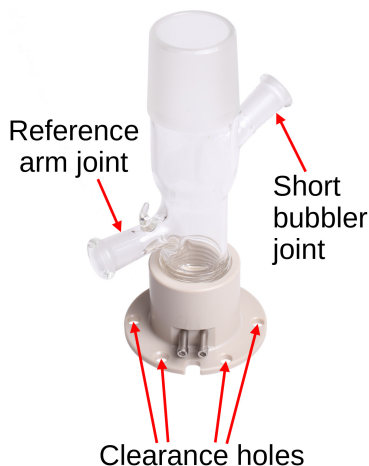

Figure 10: Glass body installed on the JW cell base.

5.2.3 Loading Microgrooved Wafers

5.2.3.1 Identifying the Face Angle of a Wafer

Microgrooved wafers are available in a choice of two different face angles: 35° and 55°. To identify the face angle of the wafer, observe the ends of the grooves. The ends of the 35° grooves are capped by a triangle (Figure 11a), while the ends of the 55° grooves are square (Figure 11b). The orientation of the grooves with respect to the wafer length and width is not a reliable indicator of the face angle. Please use the ends of the grooves to identify the wafer face angle.

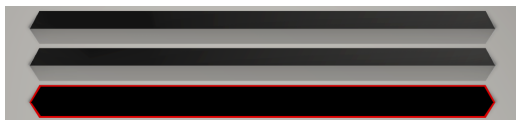

Figure 11(a): The ends of the 35° groove profile are triangular.



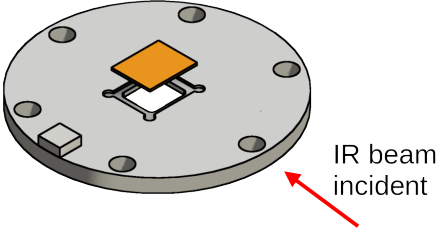
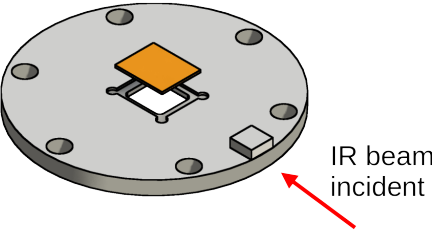

Figure 11(b): The ends of the 55° groove profile are square.

5.2.3.2 Orienting and Sealing the Wafer in the Cell

The microgrooved wafers can be installed such that the grooves are either parallel or perpendicular to the incident beam. *The performance is comparable for both orientations for most applications.*

If one orientation is preferred for a given set of experimental conditions, take note of the direction of the grooves

with respect to the side-lengths of the wafer. (Some wafers have the grooves aligned parallel to the long side-length of the wafers, while others have the grooves aligned parallel to the short side-length.) Place the wafer holder in the VeeMAX III top plate and place the coated wafer groove-side down in the holder. Rotate the wafer holder in the pocket of the VeeMAX top plate such that the incident beam is oriented with respect to the grooves according to the desired result. Use the table below as a guide to aid installation.

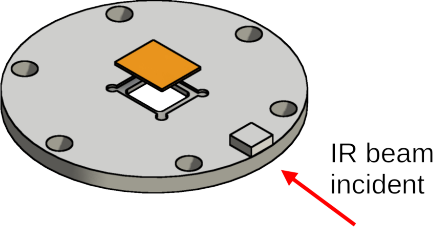
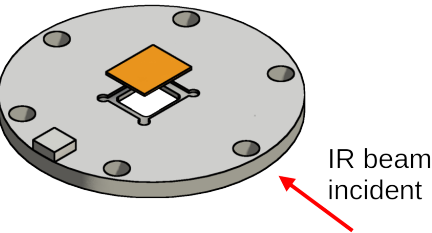
	IR beam parallel to grooves	IR beam perpendicular to grooves
Wafer grooves are parallel to short side-length. 	 IR beam incident Alignment nub faces front of VeeMAX.	 IR beam incident Alignment nub faces side of VeeMAX.
Wafer grooves are parallel to long side-length. 	 IR beam incident Alignment nub faces side of VeeMAX.	 IR beam incident Alignment nub faces front of VeeMAX.



IMPORTANT: The microgrooved wafers are brittle and can easily snap if mishandled. To avoid wafer breakage, ensure that the pins are flush with the body and the O-ring is level and as deep in its pocket as possible. In the next steps, avoid twisting motions or applying uneven pressure to one side of the cell.

Orient the body so that the notch in the flange is over top of the alignment nub on the wafer holder (Figure 12). Carefully slide the notch over the alignment nub, holding the cell at an angle to avoid scratching or moving the wafer. Then, gently lower the body onto the wafer so that it is sandwiched between the body and the wafer holder.

5.2.4 Fasten the Cell to the Top Plate

Carefully install the #8-32 screws through the clearance holes and into the VeeMAX III top plate, but do not tighten them completely yet. Note: depending on the orientation of the wafer, you will need either four or six screws to fasten the cell onto the top plate. When all the screws are in place, grip the cell by the base and gently push down to compress the O-ring against the wafer. Working in a star pattern (Figure 6), tighten each screw $\frac{1}{4}$ to $\frac{1}{2}$ turn, working your way around the cell until each screw is snug but not tight against the body. Do not over tighten the screws - this risks breaking the wafer! The O-ring is very soft, so only moderate pressure is needed to maintain a good seal. Test the seal by pipetting 1 or 2 mL of solution into the cell and observing for several minutes.



Figure 12: Sealing the wafer in the cell. This step should be done with the wafer holder installed in the VeeMAX III top plate (not shown for clarity).

5.2.5 Making Contact with the Wafer

Loosen each nylon pin-retaining screw several turns to back it off the pin. You may hear a small click as the pin extends and contacts the wafer surface. Check for proper contact by measuring the resistance across the two stainless-steel contact screws.

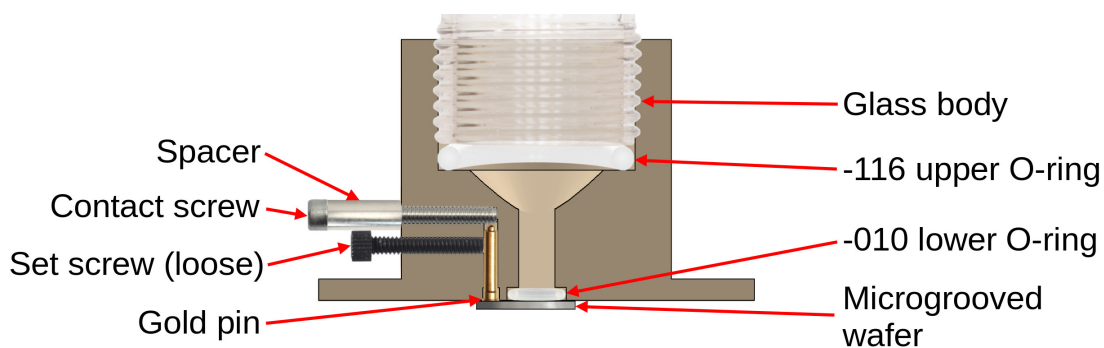

Figure 13: Cross-section of the JW cell assembled atop the crystal. The wafer holder is omitted for clarity.



IMPORTANT: There is a small chance of breaking a wafer due to the impact of the pin. To eliminate this chance, it is possible to omit the nylon pin-retaining screws during assembly. It is challenging to assemble the cell by this alternative method since neither the pins nor the wafer are held in place. The basal plane of the cell needs to be held nearly vertically (Figure 14). Take care that the wafer does not fall out and break. It will not be possible to reliably use an electroless deposited film using this “omitted nylon screw” method, since the pins can scrape the film and damage it during assembly, preventing electrical contact.



Figure 14: Alternative, more challenging assembly method to mitigate the risk of breaking wafers without using the nylon pin-retaining screws.

6 J1 Glassware

6.1 Packing List

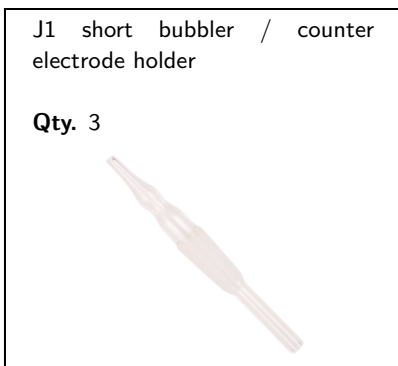
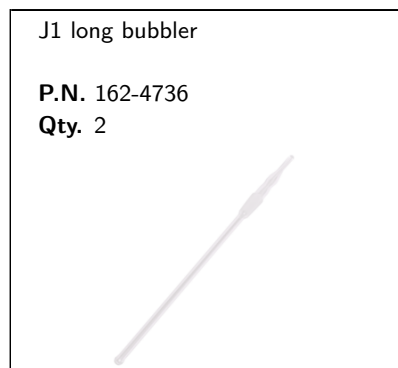
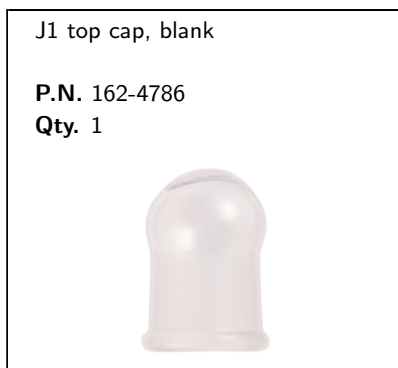
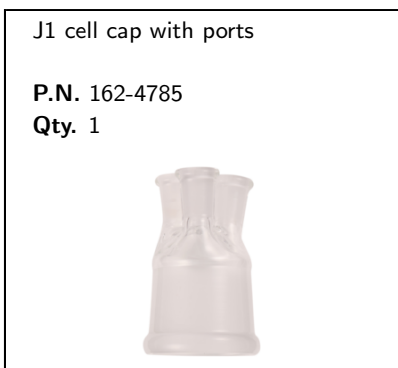
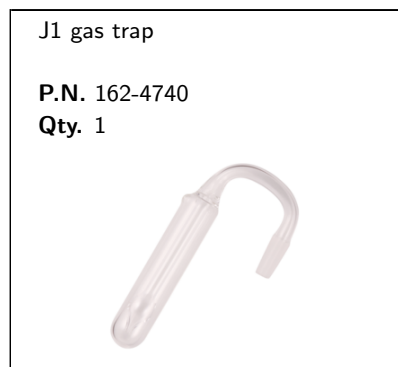
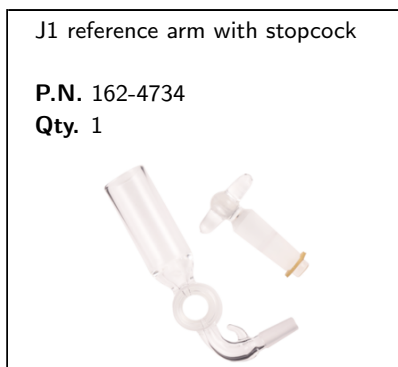
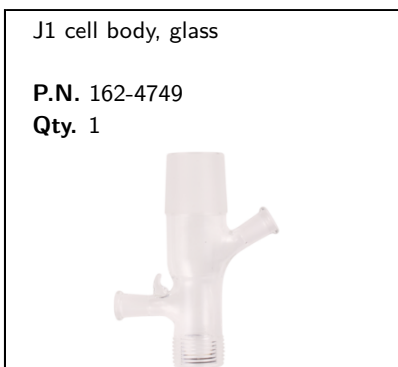

6.2 Assembling the Cell

NOTE: The ground glass joints seal best when they have a thin layer of water between them. This is especially important on the stopcock to ensure it rotates properly. It is recommended to wet all the ground glass surfaces before assembly.

1. Attach the reference arm with the stopcock to the cell body and secure it with the spring.
2. After filling the cell with electrolyte, place the bubblers, gas trap, and counter electrode in the cell. The port for the long bubbler is indicated with a glass nodule. Best practice is to have the reference arm stopcock closed when first filling the cell with electrolyte and during the subsequent step.
3. Purge the cell with inert gas for at least 30 minutes to ensure there are no leaks, and remove dissolved oxygen before fastening the assembled cell on the VeeMAX III. After the solution is purged, open the stopcock while plugging the hole on the gas trap to fill the reference arm. Close the stopcock when sufficient solution is in the reference arm.



Figure 15: Complete J1FP cell assembly.









NOTE: The absolute orientation of the side ports with respect to the VeeMAX III is not critical. Do not overtighten the cell body onto the cell base trying to obtain a particular alignment of the side ports.

6.2.1 J1 Reference Electrode Assembly

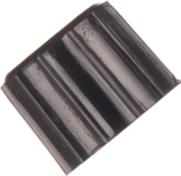
The optional reference electrode (RE) is an Ag/AgCl wire enclosed in a glass holder with a frit at one end. The RE must be filled with saturated KCl solution before operation. To do this, unscrew the black cap on the RE and remove the wire. Then, fill the glass holder with solution and reattach the cap. For information concerning reference electrode maintenance, see Section [11](#).

7 J2 Glassware

7.1 Packing List

<p>Main cell body, glass P.N. 162-4761 Qty. 1</p> 	<p>User-serviceable reference electrode Ag/AgCl P.N. 162-4774 Qty. 1</p> 	<p>9/16"-18 POM cap with aperture P.N. 162-4763 Qty. 2</p> 
<p>GL-25 cap, solid (colour may vary) P.N. 162-4775 Qty. 1</p> 	<p>GL-25 cap w/ 15mm aperture, red Qty. 1</p> 	<p>Beige PTFE-faced silicone septum for GL-25 cap P.N. 162-4762 Qty. 5</p> 
<p>Red PTFE-faced silicone septum for sidearm P.N. 162-4765 Qty. 4</p> 	<p>-107 FKM o-ring, 75A durometer, brown Qty. 4</p> 	<p>-107 FFKM o-ring, 75A durometer, black P.N. 162-4764 Qty. 2</p> 

7.2 Assembling the Cell

1. Unscrew the cap of the Ag/AgCl reference electrode and fill with 3M KCl (Figure 16). Once the electrode has been filled for the first time, the frit should not be allowed to dry out. The reference electrode should be stored in 3M KCl when not in use to prolong its life. Allow 24 hours for the frit to become wetted. The wire can be reconditioned as required by following the instructions provided in Section 11.
2. Slip a -107 O-ring over the glass part of the counter electrode and do the same for the reference electrode. Insert the counter electrode into the upper side-port and tighten down the compression cap onto the O-ring to seal it in place. Likewise, insert the reference electrode into the lower side-port and tighten down the compression cap onto the O-ring to seal it in place. If either electrode is not required, a silicone septum may be used to block off the side port (the red side is PTFE-coated and should face the solution side).
3. Install the silicone septum into the top cap with the tan-colored PTFE coating facing the bottom. Screw the cap onto the cell body.
4. Purge gas may be introduced to the cell via stainless steel needles through the septum. When purging the cell with inert gas, be sure to install an uncapped needle into the septum to allow the gas to exhaust and prevent pressure from building up in the cell.



Figure 16: J2 reference electrode: unscrew the cap and remove the wire and O-ring to fill the reference electrode.



Figure 17: Complete J2WP cell assembly.

8 Gas Purge Top Cap Option

8.1 Packing List

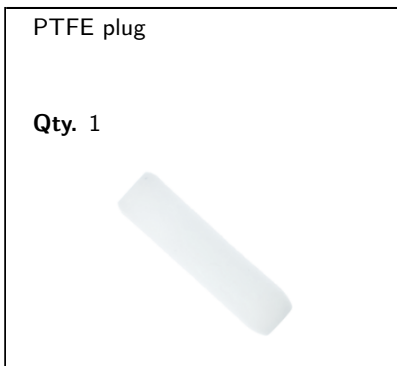
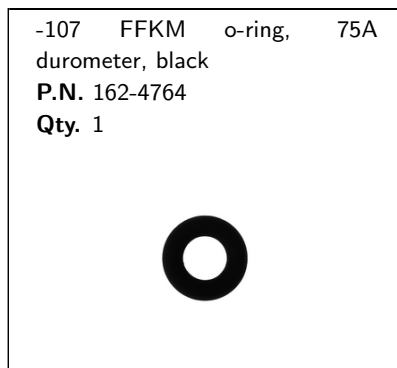
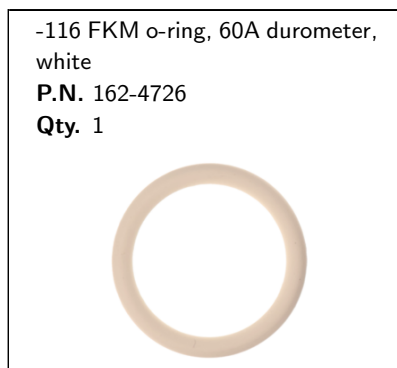
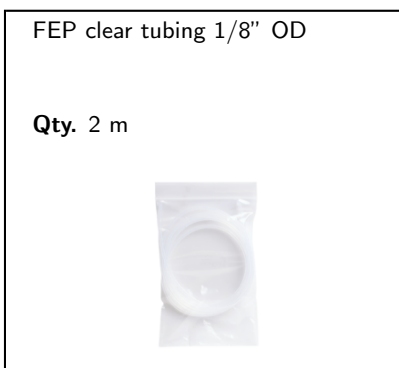
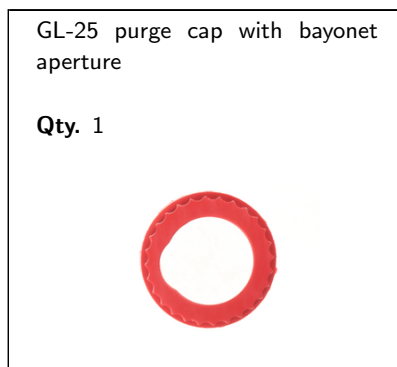
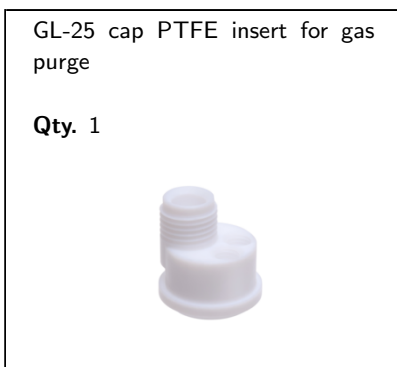
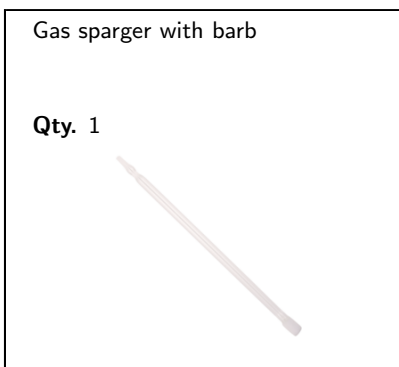

8.2 Assembly

If you have the optional gas-purge GL-25 cap, install the PTFE insert into the GL-25 cap with the notch. Align the PTFE external thread to the notch in the cap, feed the insert through the cap, and rotate to secure the cap to the PTFE insert. Install a size -116 O-ring under the insert to seal the cap to the glass cell.

Insert a PEEK fitting over the end of a section of semi-rigid FEP tubing, with the threaded side towards the end of the tube. Insert a ferrule over the end of the tubing, with the narrow end of the cone facing the PEEK fitting (Figure 18).



Figure 18: Installation of PEEK fitting and ferrule onto semi-rigid tubing.

Screw the fitting into the PTFE insert. The length of tubing which extends into the cell body may be adjusted by loosening the fitting slightly and pushing or pulling the tube. A long bubbler (i.e. sub-surface electrolyte purge) may be created in this way. The second port may be used either with a short portion of tube protruding into the cell to purge the headspace of the cell, or alternatively as a gas exhaust port if the purge gas needs to be collected rather than vented into the workspace.

The large accessory port may be used with the fritted gas dispersion bubbler or as an alternative electrode port. It may also be used to install an optional exhaust gas trap. The port is an O-ring compression-style port similar to the side arm ports of the cell. A -107 sized O-ring should be used, and the port can accommodate any shaft from 4 to 7 mm in diameter. If the port is not required, a PTFE plug may be used to block it off.

9 Installing the Jackfish Cell Assembly onto the VeeMAX III

Once the Jackfish cell has been assembled completely and checked for leaks, the assembly is transferred to the VeeMAX III base.

It is recommended to remove the cover of the sample compartment of the spectrometer, to allow for more convenient routing of the tubing. The VeeMAX should be fitted with its purge tubes to seal the optical path, so it may be purged to eliminate the effects of atmospheric CO₂ and H₂O vapour.

1. The front cover of the VeeMAX III may be removed, which makes the installation of the VeeMAX Jackfish top plate easier. The front cover is attached with four thumbscrews.
2. Remove the standard VeeMAX top plate with the rectangular opening by unscrewing the four screws, two on each side of the VeeMAX. Slowly lift the top plate off the base.
3. Replace the top plate with the Jackfish assembly mounted on the VeeMAX Jackfish top plate. Be sure to fit the threaded rod, which is used for angular settings, into the brass bushing on the underside of the Jackfish top plate. If the VeeMAX Jackfish top plate does not seat properly in the opening, the most likely causes are: a) the top of the threaded rod used for angle adjustment is not fitted into the brass bushing, or b) the wave washer located below the thumb screw is ajar. If the latter, re-seat the wave washer flat and reassemble.

10 Selecting the Angle of Incidence

Refer to the table below to choose an angle of incidence. The values given should be treated as a starting point for further optimization based on the needs of the end user's experiment.

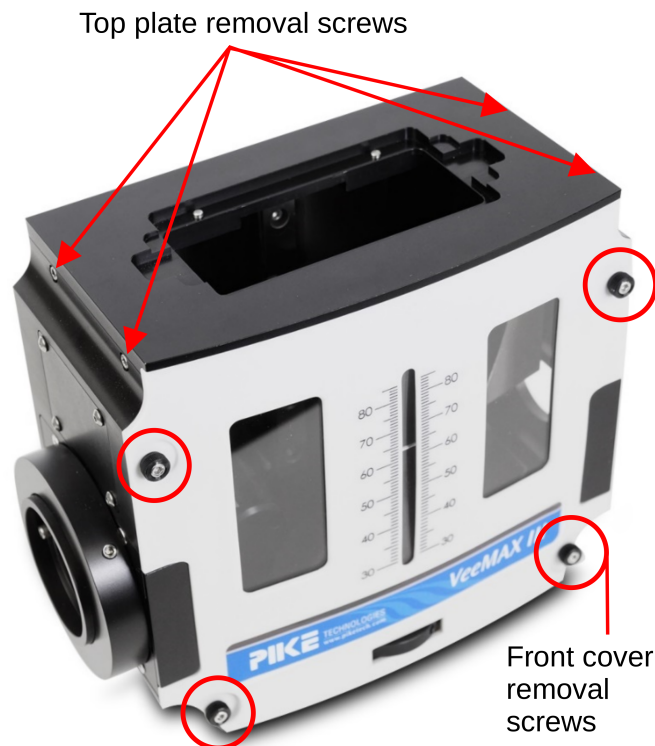

Figure 19: VeeMAX III shown with removable standard top plate.

ATR Element	PIKE Part Number	Recommended VeeMAX setting for SEIRAS	Effective Angle of Incidence
PIKE 60 degree FAC	160-5552	75°	64.4°
35 degree microgrooved wafer	162-4814	55°	40.8°
55 degree microgrooved wafer	162-4816	35°	49.2°

A calculator is available on the Jackfish SEC website to determine the effective angle of incidence from the setting chosen on the VeeMAX for a variety of crystal materials. Visit <https://jackfishsec.com/angle> to access the calculator.

11 Ag/AgCl Reference Electrode Maintenance

After prolonged use, Ag/AgCl reference electrodes (RE) can degrade. This is visible by color change of the normally black AgCl wire. To recondition the RE, sand the wire with fine grit sandpaper and oxidize it in a 10% v/v HCl solution. This can be done by gradually ramping the potential of the Ag wire versus a Pt wire until a potential of ca. +500 mV is obtained. The wire should visibly darken. The wire should then be allowed to oxidize at this potential for at least several hours, but preferably one working day. Typically, reference electrode maintenance is performed in a beaker, outside of the electrochemical cell.

12 Cleaning

Machining and glassblowing residues may still be present on the included parts. The cell should be cleaned before first use. Glass, PTFE and ETFE components can be cleaned according to standard electrochemistry cleaning protocols. Note that PTFE and ETFE may deform if exposed to heat, so any cleaning solutions should be allowed to cool after preparation. PEEK can be damaged by some concentrated acids; suggested cleaning solutions for

PEEK are: 1M HCl, 20% HNO₃, or 2M NaOH.

13 Comments on Material Properties and Chemical Compatibility

It is up to you as the user to determine the chemical compatibility requirements of your experiments. The brief comments provided here are intended only as a general introduction. Chemical resistance tables should be consulted, and tests conducted if there is any concern about the chemical resistance of the flow cell materials.

- **ETFE** (Known most widely as Tefzel™) is a copolymer of ethylene and tetrafluoroethylene which has comparable chemical resistance to PTFE.
- **FKM** (Known most widely as Viton™) is a fluorocarbon elastomeric material. It offers decent general resistance to most aqueous chemicals, with numerous exceptions. FKM is generally not suitable for contact with ethers, ketones and aldehydes.
- **FFKM** (Known most widely as Kalrez™, Chemraz™ and Simriz™) is a perfluorocarbon elastomer with a higher percentage of fluorine than standard FKM. This imparts greater resistance to most chemicals, including many organic solvents. There are many specialized types of FFKM elastomers produced, each with unique chemical resistance properties.
- **PTFE** (Known most widely as Teflon™) is a polymer of tetrafluoro ethylene which has superb chemical resistance.
- **PEEK**, polyether etherketone, is a rigid polymer with excellent mechanical properties and reasonably good chemical resistance, one notable exception being concentrated oxidizing acids.

Viton™, Teflon™, and Tefzel™ are trademarks of [THE CHEMOURS COMPANY FC, LLC](#).

Kalrez™ is a trademark of [DUPONT POLYMERS, INC.](#)

Chemraz™ is a trademark of [GREENE, TWEED TECHNOLOGIES, INC.](#)

Simriz™ is a trademark of [Carl Freudenberg KG](#).

14 Support

This manual and future updates are made available online at <https://jackfishsec.com/support>.

We have a blog which addresses some common questions such as preparing internal reflection elements for ATR-SEIRAS and selecting the optimal angle of incidence. Check it out at <https://jackfishsec.com/blog>.

We'd love to hear from you! Questions and feedback can be directed towards info@jackfishsec.com.

15 Also Available From Jackfish SEC

J3 Easy Electrochemistry "EEL" Flow Cell



A cell with a small internal volume and flow capabilities, allowing researchers to investigate complex and dynamic surface phenomena.

J4 H-Cell



A cell with two glass compartments separated by a user-supplied membrane. Includes a quartz window for visual inspection of the working electrode.

Electroless Deposition Kit



Enables users to chemically modify the reflecting plane of a face-angled crystal with a metal film.

Si Microgrooved Wafers



Uncoated microgrooved silicon wafers, available in a choice of two different face angles: 35° and 55°.



www.piketech.com | info@piketech.com | 608.274.2721 | Madison, WI USA

© Copyright PIKE Technologies, Inc. All world rights reserved.