



# Jackfish J3 Easy Electrochemistry Flow Cell

The information in this publication is provided for reference only. All information contained in this publication is believed to be correct and complete. PIKE Technologies, Inc. shall not be liable for errors contained herein nor for incidental or consequential damages in connection with the furnishing, performance, or use of this material. All product specifications, as well as the information contained in this publication, are subject to change without notice. This publication may contain or reference information and products protected by copyrights or patents and does not convey any license under the patent rights of PIKE Technologies, Inc. nor the rights of others. PIKE Technologies, Inc. does not assume any liability arising out of any infringements of patents or other rights of third parties.

This document contains confidential or proprietary information of PIKE Technologies, Inc. Neither this document nor the information herein is to be reproduced, distributed, used or disclosed, either in whole or in part, except as specifically authorized by PIKE Technologies, Inc.

PIKE Technologies, Inc. makes no warranty of any kind with regard to this material including, but not limited to, the implied warranties of merchantability and fitness for a particular purpose.

Copyright 1991-2025 by PIKE Technologies, Inc., Madison, WI 53719. Printed in the United States of America. All world rights reserved. No part of this publication may be stored in a retrieval system, transmitted, or reproduced in any way, including but not limited to, photocopy, photograph, magnetic or other record, without the prior written permission of PIKE Technologies, Inc.

Address comments to:

PIKE Technologies, Inc.  
6125 Cottonwood Drive  
Madison, WI 53719

<b>Phone</b>	(608) 274-2721
<b>Fax</b>	(608) 274-0103
<b>Email</b>	<a href="mailto:info@piketech.com">info@piketech.com</a>
<b>Web Site</b>	<a href="http://www.piketech.com">www.piketech.com</a>

April 6, 2025

# Contents

<b>1</b>	<b>Introduction</b>	<b>1</b>
<b>2</b>	<b>The J3 Cell</b>	<b>2</b>
2.1	Packing List	2
2.1.1	Option 1: J3 Face-Angled Crystal Cell, PEEK	4
2.1.2	Option 2: J3 Wafer Cell, PEEK	4
<b>3</b>	<b>Assembling the Flow Cell</b>	<b>5</b>
3.1	Installing the Contact Pins	5
3.2	Assembly and Installation of Side/Top Port Accessories	5
3.2.1	Reference Electrode Assembly	5
3.2.2	Reference Electrode Maintenance	6
3.2.3	Installing Side Port Electrodes and Top Port Gas Trap	6
3.3	Attaching Inlet and Outlet Fittings and Tubing	7
3.3.1	Recommendations For Supply and Discharge Vessels	8
<b>4</b>	<b>Loading the ATR Crystal</b>	<b>8</b>
4.1	Loading Face-Angled Crystals	9
4.2	Loading Microgrooved Wafers	9
4.2.1	Identifying the Face Angle of a Wafer	9
4.2.2	Orienting and Sealing the Wafer in the Cell	10
4.3	Fastening the Cell to the Top Plate	10
4.4	Making Contact with the Working Electrode	11
<b>5</b>	<b>Installing the Jackfish Cell Assembly onto the VeeMAX III</b>	<b>11</b>
5.1	Selecting the Angle of Incidence	12
<b>6</b>	<b>Cleaning</b>	<b>13</b>
<b>7</b>	<b>Comments on Material Properties and Chemical Compatibility</b>	<b>13</b>
<b>8</b>	<b>Support</b>	<b>13</b>
<b>9</b>	<b>Also Available From Jackfish SEC</b>	<b>14</b>

# 1 Introduction

The Jackfish Easy Electrochemical “EEL” Flow Cell enables fundamental studies of the electrified metal-solution interface and applications in molecular self-assembly, interfacial sensing, and next-generation energy solutions. It is designed for surface-sensitive FTIR spectroelectrochemistry using the attenuated total reflectance surface-enhanced infrared absorptions spectroscopy (ATR-SEIRAS) technique. High quality IR spectra can be obtained from sub-monolayer amounts of adsorbed molecules. By controlling the electrical potential applied to a thin film electrode on the ATR crystal surface, the user can perform vibrational characterization of potential-dependent changes at the interface.

By design, the cell is fully compatible with the PIKE VeeMAX III variable angle ATR sampling accessory. Two different crystals can be accommodated: either PIKE face-angled crystals (FAC) or microgrooved Si ATR wafers. In a previous study investigating the adsorption of a pyridine derivative, the spectral response was two times stronger when using Si 60 degrees FAC compared to a Si hemisphere with an angle of incidence of 65 degrees<sup>1</sup>. Additionally, the FAC exhibited higher energy throughput and lower spectral noise. The short pathlength through the ATR wafers allows improved signal-to-noise in the fingerprint region of the IR spectrum and a lower frequency cutoff compared to the FAC.

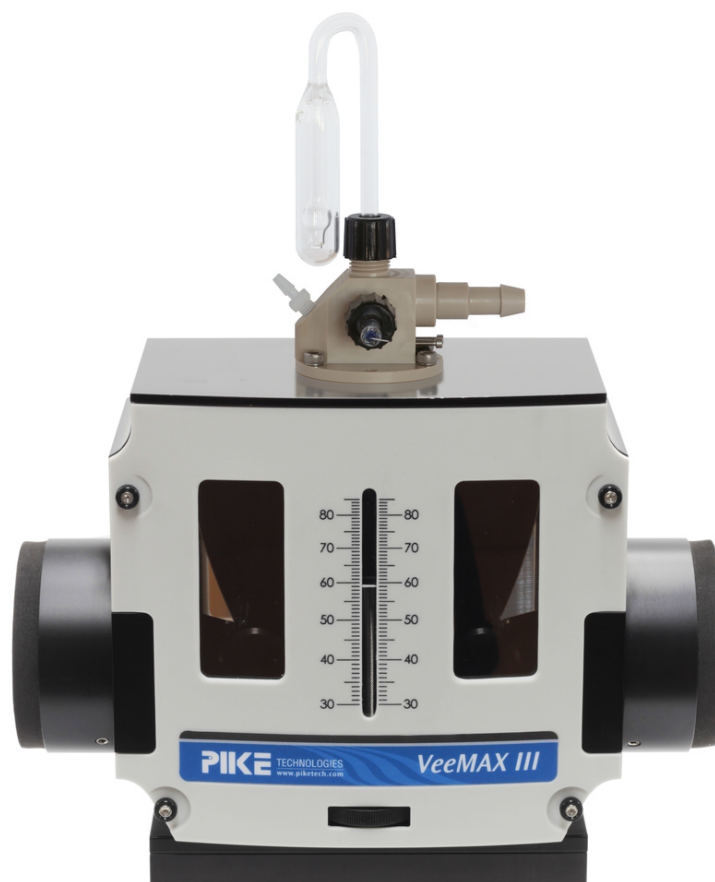









Jackfish Easy Electrochemical “EEL” Flow Cell assembled on the VeeMAX III accessory.

<sup>1</sup>Sigrist, J. A. et al. Optimization of a Commercial Variable Angle Accessory for Entry Level Users of Electrochemical Attenuated Total Reflection Surface-Enhanced Infrared Absorption Spectroscopy (ATR-SEIRAS). *Applied Spectroscopy* **2019**, 73 (12), 1394–1402, DOI: [10.1177/0003702819858353](https://doi.org/10.1177/0003702819858353).

## 2 The J3 Cell

In order for you to quickly verify receipt of your accessory, we have included a packing list. Please inspect the package carefully. Contact PIKE Technologies immediately if any discrepancies are found.

### 2.1 Packing List

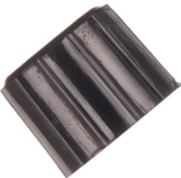
<p>Flow cell body, PEEK</p> <p>P.N. 162-4835</p> <p>Qty. 1</p> 	<p>User-serviceable reference electrode Ag/AgCl</p> <p>P.N. 162-4774</p> <p>Qty. 1</p> 	<p>Gas trap 6mm tube</p> <p>P.N. 162-4836</p> <p>Qty. 1</p> 
<p>1.6mm barb to 1/4"-28 fitting, PTFE</p> <p>Qty. 1</p> 	<p>3.2mm barb to 1/4"-28 fitting, PTFE</p> <p>Qty. 1</p> 	<p>4.8mm barb to 1/4"-28 fitting, PTFE</p> <p>Qty. 1</p> 
<p>1/2" - 20 PEEK to 3/8" barb outlet fitting</p> <p>P.N. 162-4838</p> <p>Qty. 1</p> 	<p>1/2" - 20 PTFE plug</p> <p>Qty. 1</p> 	<p>9/16"-18 POM cap with aperture</p> <p>P.N. 162-4763</p> <p>Qty. 3</p> 

Red PTFE-faced silicone septum for sidearm  
P.N. 162-4765  
Qty. 4



-004 FKM o-ring, 60A durometer, white  
Qty. 2



-010 FKM o-ring, 60A durometer, white  
P.N. 162-4725  
Qty. 2



-107 FKM o-ring, 75A durometer, brown  
Qty. 6



-010 FFKM o-ring, 75A durometer, black  
P.N. 162-4772  
Qty. 1



-107 FFKM o-ring, 75A durometer, black  
P.N. 162-4764  
Qty. 4



#8-32 screw, stainless steel, 1/2" long  
Qty. 8



#2-56 contact screw, stainless steel  
Qty. 4



#2-56 pin-retaining screw, nylon black  
Qty. 4



Gold pogo pin  
Qty. 4



Contact screw spacer, stainless steel  
Qty. 2



5/64" ball-end screwdriver  
Qty. 1



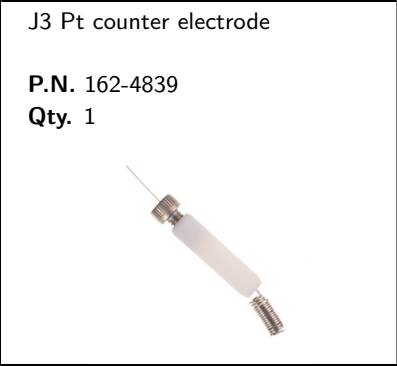
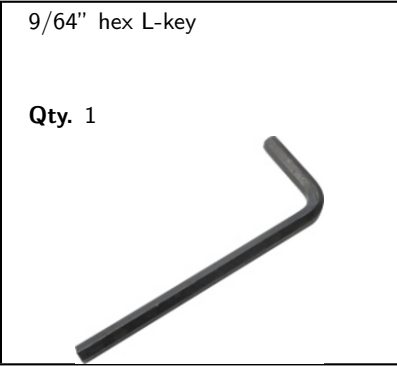

**2.1.1 Option 1: J3 Face-Angled Crystal Cell, PEEK**



**2.1.2 Option 2: J3 Wafer Cell, PEEK**



## 3 Assembling the Flow Cell

### 3.1 Installing the Contact Pins

Slide a contact screw spacer over two of the #2-56 stainless steel contact screws (Figure 1a). Use the 5/64" hex screwdriver to install the contact screws into the uppermost screw holes on the front of the cell base (Figure 1b). Tighten them until they bottom out onto the spacer. Place a gold contact pin in each hole on the bottom of the cell base. Verify that the pins protrude out from the bottom surface of the cell base by approximately 2 mm (Figure 1c). If a pin does not protrude appreciably from its hole, it is likely that the corresponding contact screw was insufficiently tightened. Remove the pin, tighten down the contact screw, and check again. It is recommended to measure the resistance between the pin and its corresponding screw to ensure electrical contact.

Depress each pin and install a nylon #2-56 screw into the remaining (lower) hole for that pin. Tighten until the nylon screw contacts the pin and retains it in the compressed state. Note: the head of the nylon screw will not seat against the side of the cell base (Figure 1d).

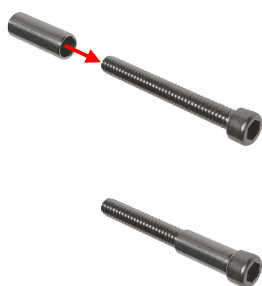

Figure 1(a): Installing the spacer on the stainless steel contact screw.

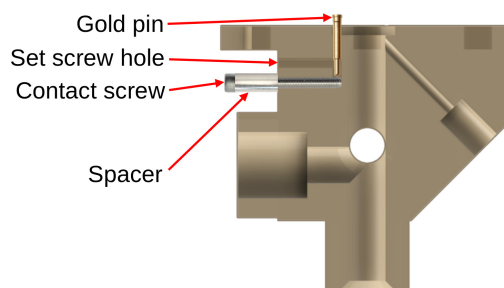

Figure 1(b): Cross-section of the J3 cell base, flipped upside down so that the gold pin does not fall out.

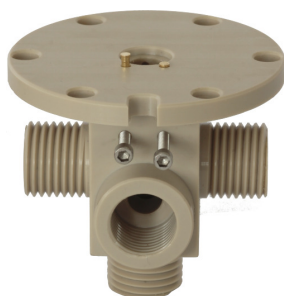

Figure 1(c): The left pin protrudes correctly, however, the right pin has sunk to the bottom of the hole because the contact screw was tightened inadequately.

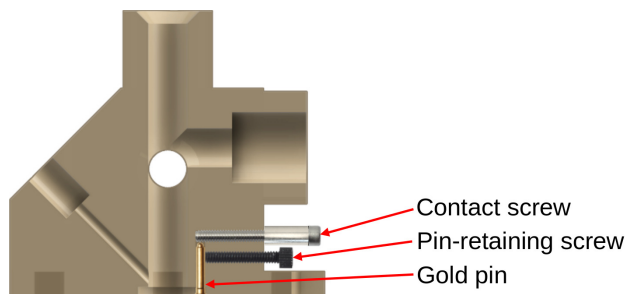

Figure 1(d): The nylon set screw retains the gold pin in the compressed state.

### 3.2 Assembly and Installation of Side/Top Port Accessories

#### 3.2.1 Reference Electrode Assembly

Unscrew the cap of the Ag/AgCl reference electrode and fill with 3M KCl using a Pasteur pipette or syringe. Take care to fill the body completely and avoid air bubbles which could cause electrical contact to be lost when the electrode is tipped on its side and inserted into the side port of the flow cell. Once the electrode has been filled for the first time, the frit should not be allowed to dry out. The reference electrode should be stored in 3M KCl when not in use to prolong its life.





Figure 2: Unscrew the cap and remove the wire and O-ring to fill the reference electrode.

### 3.2.2 Reference Electrode Maintenance

After prolonged use, the reference electrode can degrade. This is visible by color change of the normally black AgCl wire. To recondition the RE, remove the wire from the body, remove the AgCl coating by wet sanding with fine grit sandpaper and oxidize it in a 10% v/v HCl solution. This can be done by gradually ramping the potential of the Ag wire versus a Pt wire until a potential of ca. +500 mV is obtained. The wire should visibly darken. The wire should then be allowed to oxidize at this potential for at least several hours, but preferably one working day. It is recommended that reference electrode maintenance is performed in a beaker, outside of the electrochemical cell.

### 3.2.3 Installing Side Port Electrodes and Top Port Gas Trap

The J3 features three accessory ports with a 9/16" -18 external thread. These ports seal by compressing an O-ring against a straight shaft having a diameter between 4 mm and 7 mm. In a standard configuration, the suggested accessories are a reference electrode and a counter electrode for the side ports, and an exhaust gas bubbler for the top port. If any of the ports are not required, they may be blocked off using a PTFE-faced silicone septum and a cap (the red side of the septum is the PTFE side which should face the interior of the cell).

Slide a black accessory cap over the reference electrode and then slip a -107 O-ring over the body of the electrode. Likewise, place a cap and -107 O-ring over the counter electrode, taking care not to bend the wire. Finally, attach a cap and -107 O-ring on the stem of the exhaust bubbler (Figure 3).



Figure 3: Caps and O-rings installed on accessories.

Insert the reference electrode into one of the side-ports and tighten down the compression cap onto the O-ring to seal it in place. Insert the counter electrode into the other side-port and the exhaust bubbler in the top port.

The top port acts much like a plumbing stack, preventing gas bubbles from clogging up the flow by providing a vent. In most cases, the gas trap should be installed in the top port, but it **should not** be filled with liquid. This way, the top of the cell will remain at atmospheric pressure and gas bubbles will readily exit through the top of the cell.

	<p><b>Note:</b> When installing the electrodes and exhaust bubbler, ensure that the accessories do not extend too deeply into the cell. An improperly positioned accessory may interfere with other accessories or impede the flow of solution through the cell. Adjust the position of an accessory by sliding the O-ring along the shaft while looking through an orthogonal port. Secure the accessory's position by fastening the cap. This method allows adjustment and verification of the correct positioning of the accessories within the volume of the cell (Figures 4a and 4b).</p>
---	--



Figure 4(a): When installing the counter electrode, look through the top port and confirm that the wire is visible when the O-ring is seated on the accessory port (adjust position of the O-ring on the shaft if necessary). The reference electrode should be just barely visible through the top port and should not interfere with the counter electrode.



Figure 4(b): Look through the outlet port when installing the gas trap. In this case, the bubbler has been installed too deeply into the cell and it is blocking the outlet port.

### 3.3 Attaching Inlet and Outlet Fittings and Tubing

The inlet port is threaded for 1/4"-28 to accept standard chromatography fittings. Inlet barb fittings are supplied for 1/16, 1/8 and 3/16" (1.6, 3.2 and 4.8 mm) ID soft tubing with the expectation that most users will be using a peristaltic pump with soft tubing. An optional -004 FKM O-ring is included and may be placed at the bottom of the inlet hole before installing the fitting. This O-ring improves sealing reliability, however if FKM is incompatible with the flow solutions, it may be omitted, and the inlet fitting may be fastened directly into the hole.

The outlet port is threaded for 1/2"-20, and should be installed with a -107 O-ring at the bottom of the hole. The included barb fitting is designed for 3/8" or 10 mm ID soft tubing. The outlet port is designed to be larger than the inlet port to facilitate efficient turnover of the cell volume and to prevent blockages from gas bubbles. Please use the largest diameter tubing available on the outlet port. If semi-flexible (aka semi-rigid) tubing is preferred, IDEX Corp. offers two fittings for use with semi-flexible tubing which are compatible with the 1/2"-20 thread: part number [XU-655](#) for 1/4" OD tubing and part number [XU-662](#) for 5/16" OD tubing.



The flow cell is designed to use straight threads and O-rings to seal the various ports. This method of sealing is highly reliable for low pressure applications and the fittings can be assembled and disassembled many times without failure. Unlike tapered thread seals, O-ring seals do not have a spiral leak path through the thread, and Teflon™ tape should not be applied to the threads. If leaks occur: (1) ensure that the fittings are fastened snugly (finger-tight should be sufficient); (2) replace the O-rings if damaged or misshapen due to compression set or chemical exposure; (3) examine the sealing surfaces for damage.

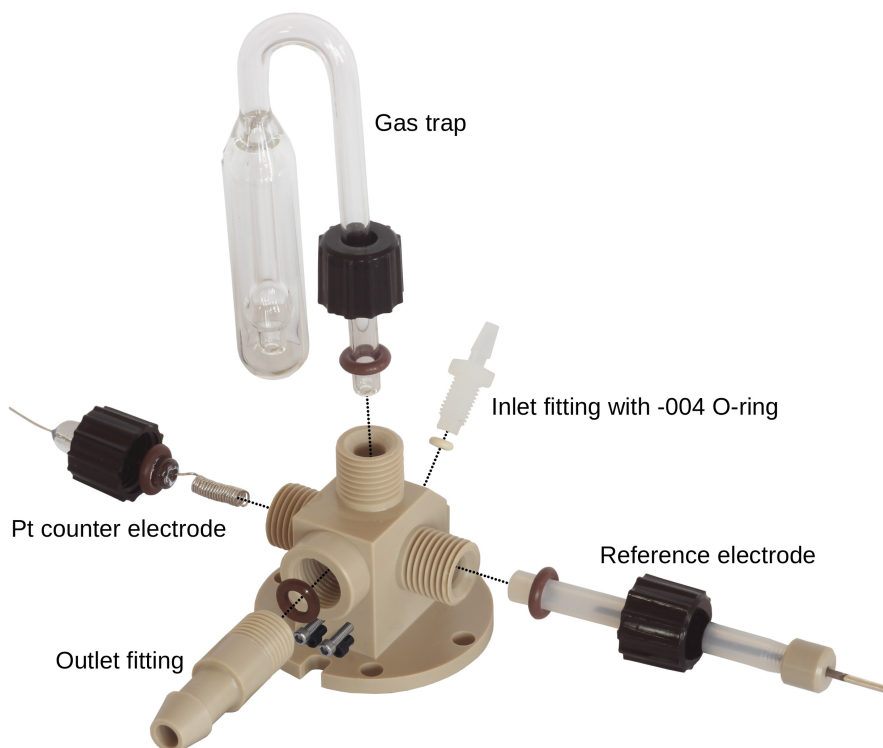

Figure 5: Exploded view of the standard 3-electrode flow cell setup.

### 3.3.1 Recommendations For Supply and Discharge Vessels

In most experimental setups, it should be sufficient to pre-purge the supply vessel upstream of the pump with inert gas to remove dissolved oxygen. The flow cell can likewise be purged with inert gas prior to pumping any liquid through it. However, if performing a static, non-flow experiment, inert gas may be introduced to the cell via the inlet port. In this case, the gas trap may be filled with the solvent in the cell to monitor the gas flow.

The waste container from the outlet should be placed at a level below the output port. This ensures efficient discharge and prevents the fluid level in the cell rising out of the top port.

Note: The outlet port is positioned at a higher level than the side ports so that a small volume of liquid will be retained in the cell, such that electrical contact is not lost, even while pumping gas through the cell.

*Before proceeding to the next assembly step, it is recommended that all of the electrodes and fittings are installed, and the tubing is attached.*

## 4 Loading the ATR Crystal

After a conductive film is deposited on the surface of the ATR crystal to act as the working electrode, the crystal can be loaded into the top plate of the VeeMAX. If using Face-Angled Crystals, please follow instruction number

4.1 below; if using Microgrooved Wafers, please proceed to instruction number 4.2.

## 4.1 Loading Face-Angled Crystals

Place the coated face-angled crystal in the holder and place in the VeeMAX III top plate, as shown in Figures 6a and 6b.

 **IMPORTANT:** Remove the top plate from the VeeMAX III and secure to ensure it does not shift during assembly. The assembly and initial filling of the cell with electrolyte needs to be done off the VeeMAX III. This is to avoid damage to the VeeMAX III if a leak occurs.

 **IMPORTANT:** When placing the crystal holder with the FAC in the top plate, be sure the FAC is oriented correctly to allow for incident light through the FAC (Figure 6b).

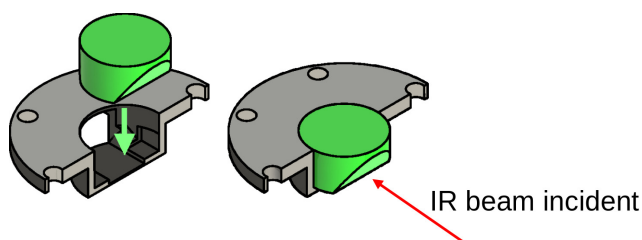

Figure 6(a): Orientation of FAC in cross-section of crystal holder.

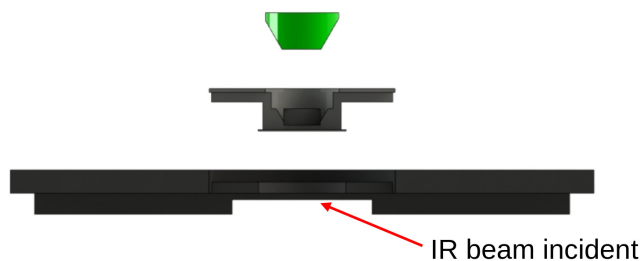

Figure 6(b): Orientation of FAC in crystal holder in top plate.

## 4.2 Loading Microgrooved Wafers

### 4.2.1 Identifying the Face Angle of a Wafer

Microgrooved wafers are available in a choice of two different face angles: 35° and 55°. To identify the face angle of the wafer, observe the ends of the grooves. The ends of the 35° grooves are capped by a triangle (Figure 7a), while the ends of the 55° grooves are square (Figure 7b). The orientation of the grooves with respect to the wafer length and width is not a reliable indicator of the face angle. Please use the ends of the grooves to identify the wafer face angle.

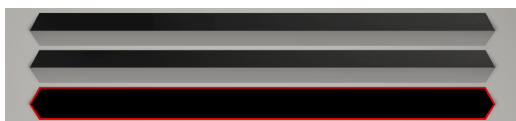

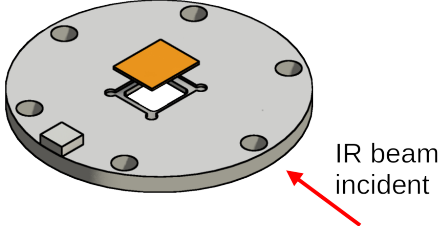
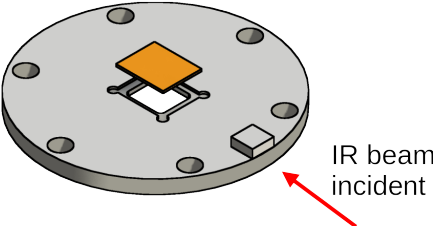

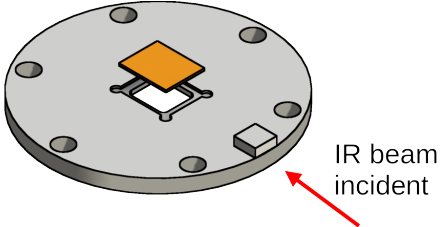
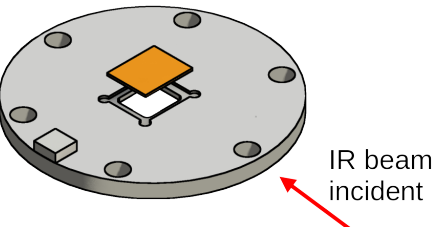



Figure 7(a): The ends of the 35° groove profile are triangular. Figure 7(b): The ends of the 55° groove profile are square.

#### 4.2.2 Orienting and Sealing the Wafer in the Cell

The microgrooved wafers can be installed such that the grooves are either parallel or perpendicular to the incident beam. *The performance is comparable for both orientations for most applications.*

If one orientation is preferred for a given set of experimental conditions, take note of the direction of the grooves with respect to the side-lengths of the wafer. (Some wafers have the grooves aligned parallel to the long side-length of the wafers, while others have the grooves aligned parallel to the short side-length.) Place the wafer holder in the VeeMAX III top plate and place the coated wafer groove-side down in the holder. Rotate the wafer holder in the pocket of the VeeMAX top plate such that the incident beam is oriented with respect to the grooves according to the desired result. Use the table below as a guide to aid installation.

	IR beam parallel to grooves	IR beam perpendicular to grooves
Wafer grooves are parallel to <b>short</b> side-length. 	 IR beam incident Alignment nub faces front of VeeMAX.	 IR beam incident Alignment nub faces side of VeeMAX.
Wafer grooves are parallel to <b>long</b> side-length. 	 IR beam incident Alignment nub faces side of VeeMAX.	 IR beam incident Alignment nub faces front of VeeMAX.



**IMPORTANT:** The microgrooved wafers are brittle and can easily snap if mishandled. To avoid wafer breakage, ensure that the pins are flush with the body and the O-ring is level and as deep in its pocket as possible. In the next steps, avoid twisting motions or applying uneven pressure to one side of the cell.

Orient the flow cell body so that the notch in the flange is over top of the alignment nub on the wafer holder (Figure 8). Carefully slide the notch over the alignment nub, holding the cell at an angle to avoid scratching or moving the wafer. Then, gently lower the body onto the wafer so that it is sandwiched between the body and the wafer holder.

#### 4.3 Fastening the Cell to the Top Plate

Carefully install the #8-32 screws through the clearance holes and into the VeeMAX III top plate, but do not tighten them completely yet. Only four screws are required; the two holes under the side ports are tooling holes used in the manufacturing of the flow cell. Working in the star pattern indicated in Figure 9, tighten each screw  $\frac{1}{4}$  turn, working your way around the cell until each screw is snug but not tight against the body. If using wafers, do not over tighten the screws - this risks breaking the wafer! The provided O-rings are soft, so only moderate

pressure is needed to maintain a good seal. To test the seal, pipette 1 or 2 mL of solution into the cell and verify that the work surface under the top plate is still dry after waiting several minutes. It is recommended to check the seals under flow on the bench to avoid leaks onto the mirrors inside the VeeMAX.



Figure 8: Sealing the wafer in the cell. This step should be done with the wafer holder installed in the VeeMAX III top plate (not shown for clarity).

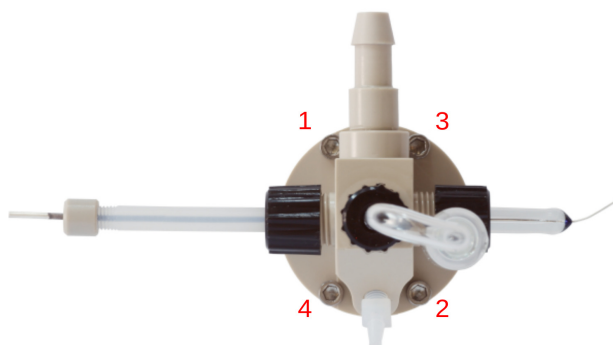

Figure 9: Fasten the screws in the order indicated to apply even sealing pressure.

#### 4.4 Making Contact with the Working Electrode

Loosen each nylon pin-retaining screw several turns to back it off the pin. You may hear a small click as the pin springs open and contacts the surface of the ATR crystal. Check for proper contact by measuring the resistance across the two stainless-steel contact screws.

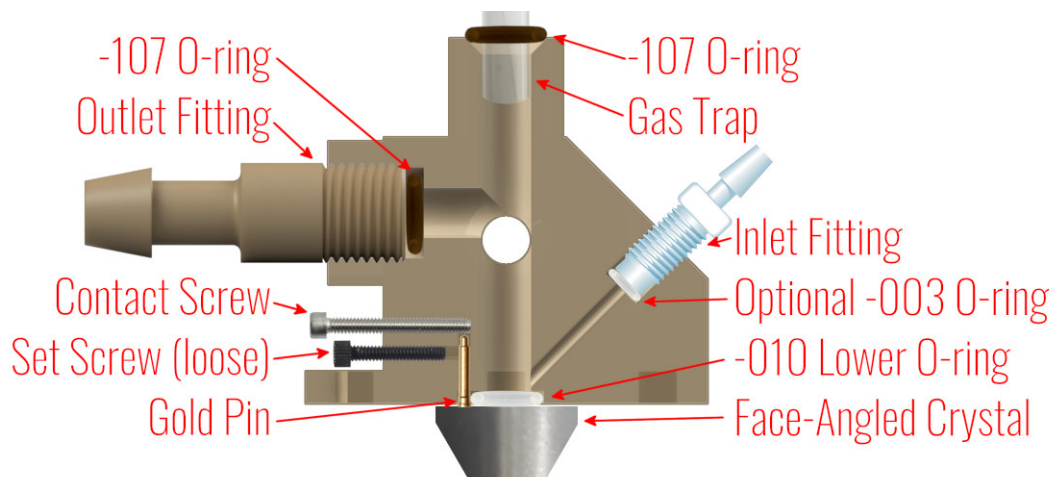

Figure 10: Cross-section of the flow cell assembled atop a face-angled crystal. The crystal holder, tubing, and electrodes are omitted for clarity.

### 5 Installing the Jackfish Cell Assembly onto the VeeMAX III

Once the Jackfish cell has been assembled completely and checked for leaks, the assembly is transferred to the VeeMAX III base.

It is recommended to remove the cover of the sample compartment of the spectrometer, to allow for more convenient routing of the tubing. The VeeMAX should be fitted with its purge tubes to seal the optical path, so it may be purged to eliminate the effects of atmospheric CO<sub>2</sub> and H<sub>2</sub>O vapour.

1. The front cover of the VeeMAX III may be removed, which makes the installation of the VeeMAX Jackfish top plate easier. The front cover is attached with four thumbscrews.
2. Remove the standard VeeMAX top plate with the rectangular opening by unscrewing the four screws, two on each side of the VeeMAX. Slowly lift the top plate off the base.
3. Replace the top plate with the Jackfish assembly mounted on the VeeMAX Jackfish top plate. Be sure to fit the threaded rod, which is used for angular settings, into the brass bushing on the underside of the Jackfish top plate. If the VeeMAX Jackfish top plate does not seat properly in the opening, the most likely causes are: a) the top of the threaded rod used for angle adjustment is not fitted into the brass bushing, or b) the wave washer located below the thumb screw is ajar. If the latter, re-seat the wave washer flat and reassemble.

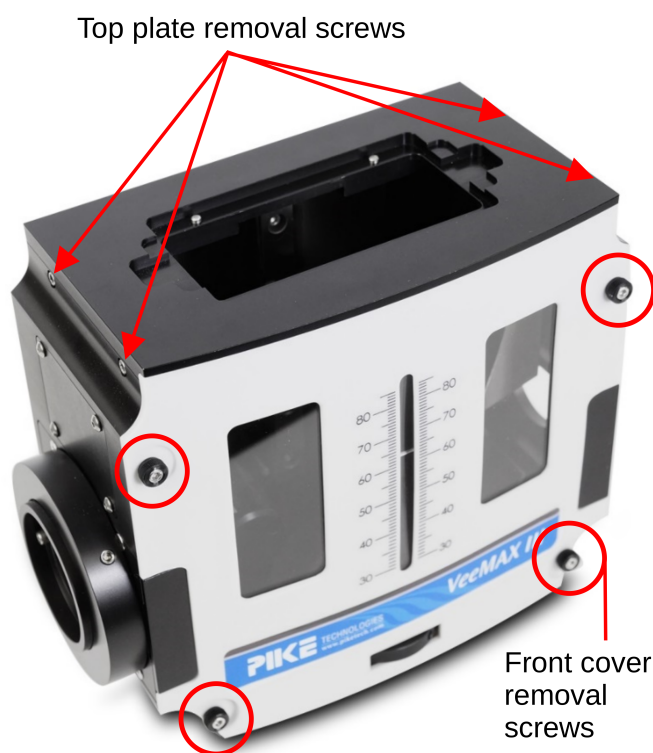

Figure 11: VeeMAX III shown with removable standard top plate.

## 5.1 Selecting the Angle of Incidence

Refer to the table below to choose an angle of incidence. The values given should be treated as a starting point for further optimization based on the needs of the end user's experiment.

ATR Element	PIKE Part Number	Recommended VeeMAX setting for SEIRAS	Effective Angle of Incidence
PIKE 60 degree FAC	160-5552	75°	64.4°
35 degree microgrooved wafer	162-4814	55°	40.8°
55 degree microgrooved wafer	162-4816	35°	49.2°

A calculator is available on the Jackfish SEC website to determine the effective angle of incidence from the

setting chosen on the VeeMAX for a variety of crystal materials. Visit <https://jackfishsec.com/angle> to access the calculator.

## 6 Cleaning

Machining and glassblowing residues may still be present on the included parts. The cell should be cleaned before first use. Glass, PTFE and ETFE components can be cleaned according to standard electrochemistry cleaning protocols. Note that PTFE and ETFE may deform if exposed to heat, so any cleaning solutions should be allowed to cool after preparation. PEEK can be damaged by some concentrated acids; suggested cleaning solutions for PEEK are: 1M HCl, 20% HNO<sub>3</sub>, or 2M NaOH.

## 7 Comments on Material Properties and Chemical Compatibility

It is up to you as the user to determine the chemical compatibility requirements of your experiments. The brief comments provided here are intended only as a general introduction. Chemical resistance tables should be consulted, and tests conducted if there is any concern about the chemical resistance of the flow cell materials.

- **ETFE** (Known most widely as Tefzel™) is a copolymer of ethylene and tetrafluoroethylene which has comparable chemical resistance to PTFE.
- **FKM** (Known most widely as Viton™) is a fluorocarbon elastomeric material. It offers decent general resistance to most aqueous chemicals, with numerous exceptions. FKM is generally not suitable for contact with ethers, ketones and aldehydes.
- **FFKM** (Known most widely as Kalrez™, Chemraz™ and Simriz™) is a perfluorocarbon elastomer with a higher percentage of fluorine than standard FKM. This imparts greater resistance to most chemicals, including many organic solvents. There are many specialized types of FFKM elastomers produced, each with unique chemical resistance properties.
- **PTFE** (Known most widely as Teflon™) is a polymer of tetrafluoro ethylene which has superb chemical resistance.
- **PEEK**, polyether etherketone, is a rigid polymer with excellent mechanical properties and reasonably good chemical resistance, one notable exception being concentrated oxidizing acids.

Viton™, Teflon™, and Tefzel™ are trademarks of [THE CHEMOURS COMPANY FC, LLC](#).

Kalrez™ is a trademark of [DUPONT POLYMERS, INC.](#)

Chemraz™ is a trademark of [GREENE, TWEED TECHNOLOGIES, INC.](#)

Simriz™ is a trademark of [Carl Freudenberg KG](#).

## 8 Support

This manual and future updates are made available online at <https://jackfishsec.com/support>.

We have a blog which addresses some common questions such as preparing internal reflection elements for ATR-SEIRAS and selecting the optimal angle of incidence. Check it out at <https://jackfishsec.com/blog>.

We'd love to hear from you! Questions and feedback can be directed towards [info@jackfishsec.com](mailto:info@jackfishsec.com).



## 9 Also Available From Jackfish SEC

J1 Spectroelectrochemical Cell



Our flagship cell. Features a separate reference arm and glass construction for ultimate cleanliness.

J2 Spectroelectrochemical Cell



A completely sealed cell with a simple design. Compatible with both aqueous and volatile solvents.

J4 H-Cell



A cell with two glass compartments separated by a user-supplied membrane. Includes a quartz window for visual inspection of the working electrode.

Electroless Deposition Kit



Enables users to chemically modify the reflecting plane of a face-angled crystal with a metal film.

Si Microgrooved Wafers



Uncoated microgrooved silicon wafers, available in a choice of two different face angles:  $35^\circ$  and  $55^\circ$ .



[www.piketech.com](http://www.piketech.com) | [info@piketech.com](mailto:info@piketech.com) | 608.274.2721 | Madison, WI USA

© Copyright PIKE Technologies, Inc. All world rights reserved.